

What's in the Box

Overview

[Product Overview](#)

[LCD Screen Guide](#)

Recharging Your Power Station

[AC Recharging \(750W Max\)](#)

[UltraFast Recharging \(1100W Max\)](#)

[Solar Panel Recharging \(300W Max\)](#)

[DC Recharging](#)

Powering On / Off

Powering Your Devices

[AC Charging](#)

[USB Charging](#)

[Car Socket Charging](#)

[Charging Compartment](#)

[AK-01 Camping Light](#)

[Recharge Your Camping Lights](#)

[Use the Extension Pole](#)

Uninterruptible Power Supply (UPS)

SurgePad™

Anker App for Smart Control

Light

[Ambient light](#)

[SOS Mode](#)

FAQ

Specifications

What's in the Box



Anker SOLIX C800X
Portable Power Station



AC Charging Cable

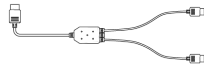

Solar Charging Cable



DC Charging Cable



Important Safety
Instructions

Overview

Product Overview

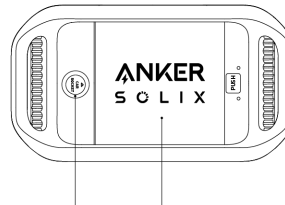
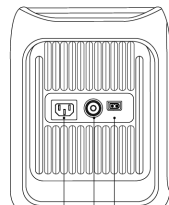
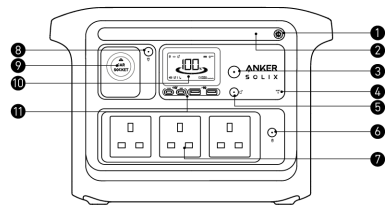

1 Ambient Light Button	2 Ambient Light
3 Main Power Button	4 Reset Button
5 IoT Button	6 AC Outlet Button
7 AC Output Ports	8 Car Socket Button
9 Car Socket	10 LCD Screen
11 USB Ports	12 AC Input Port
13 Overload Protection Switch	14 DC Input Port
15 Extension Rod Connection Hole	16 Charging Compartment for Camping Lights

LCD Screen Guide

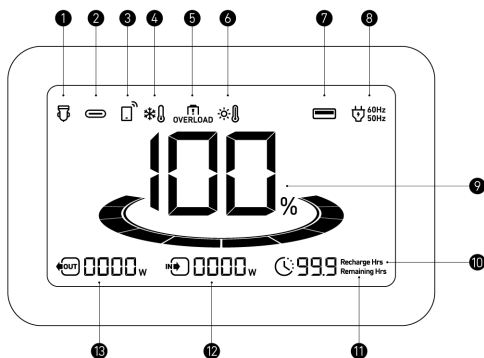

1 Car Charging

2 USB-C Output

3 IoT:

Press the IoT button once to turn on Bluetooth and Wi-Fi, and connect your devices through the app when this icon appears on the screen.

Press the IoT button for 2 seconds to turn off Bluetooth and Wi-Fi.

Press the IoT button for 7 seconds to reset Bluetooth and Wi-Fi.

4 Low-Temperature Alert: When this icon shows, stop using the power station until the icon disappears.

5 Overload Warning:

This icon appears when a port is overloaded. The port will be turned off to avoid any damage. Please remove the device causing overload.

④ High-Temperature Alert:

When this icon shows, stop using the power station and let it cool down until the icon disappears.

⑦ USB-A Output

⑧ AC Charge and Voltage Frequency

⑨ Remaining Battery for Power Station

⑩ Estimated Time to Fully Recharge

⑪ Estimated Time for Battery to Deplete

⑫ Current Input Power

⑬ Current Output Power

Recharging Your Power Station

AC Recharging (750W Max)

Recharge your power station by connecting to a wall outlet with the AC charging cable.

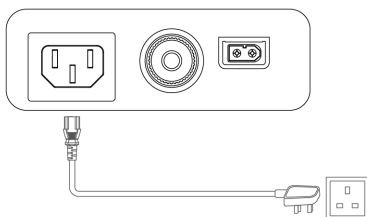

UltraFast Recharging (1100W Max)

The UltraFast charging needs to be activated from the Anker app home page.

⚠️ Regular charging provides the best protection for the battery. We recommend using UltraFast charging when necessary.

Solar Panel Recharging (300W Max)

Recharge your power station with a maximum solar input of 300W by connecting up to two solar panels, as shown in the figure, with a solar charging cable.

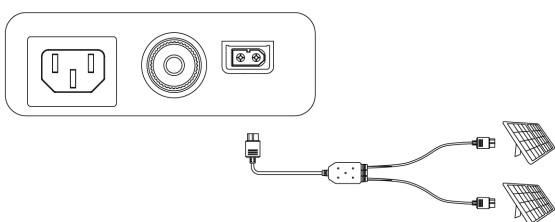

DC Recharging

Recharge your power station by connecting to a DC output port with the DC charging cable.

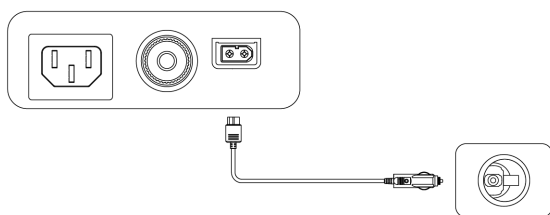

💡 When your portable power station only has 1% battery remaining, the "Remaining Battery" indicator will flicker to remind you to recharge.

Powering On / Off

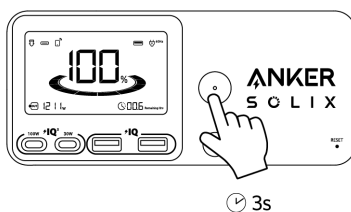

Press the main power button for 3 seconds to turn your power station on or off. When the "Remaining Battery" indicator shows on the LCD screen, your power station is ready to charge devices.

💡

- When powered on, press the main power button to turn the screen on or off.
- The screen will automatically turn off after 30 seconds of lighting up. The auto-off time can be set in the Anker app.
- The power station will power off automatically if the output buttons are turned off and no power loads are detected for 12 hours. The standby duration can be set in the Anker app.

Powering Your Devices

AC Charging

Press the AC outlet button and connect your device with the AC output ports.

The AC outlets can intelligently identify whether a plug is inserted. This helps prevent power waste by automatically turning off the power station if no plug is detected for more than 15 minutes.

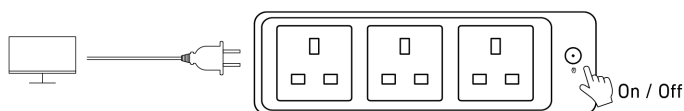

USB Charging

Connect your devices to the USB ports.

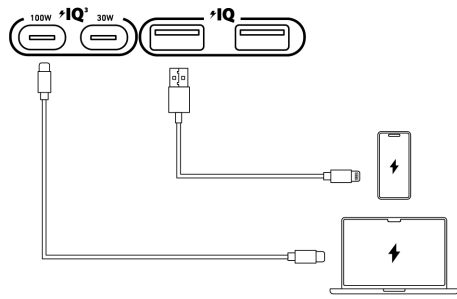

Car Socket Charging

Turn on the car socket and connect your devices to start charging.

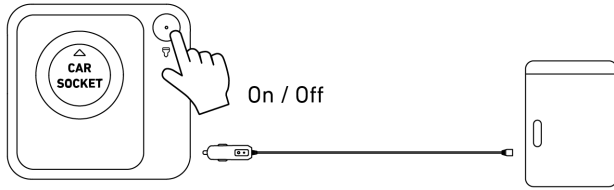

Charging Compartment

The charging compartment on the top of the product is the storage compartment for the camping lights and can charge 2 camping lights at the same time.

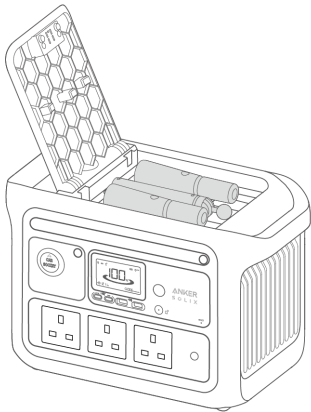

AK-01 Camping Light

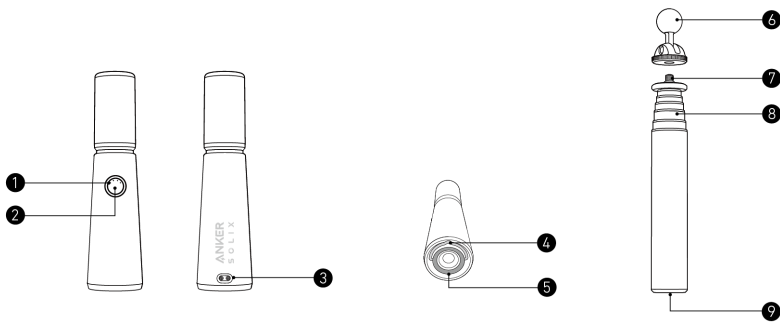

1 Power Indicator	2 Power Button
3 Pogo Pin	4 Hook
5 Magnetic Ring	6 Magnetic Ball
7 1/4" Screw	8 Multi-Function Extension Pole
9 Thread Hole	

Recharge Your Camping Lights

Charge the camping lights with the pogo pin.

- Indicators flash while charging.
- All indicators are on when fully charged.

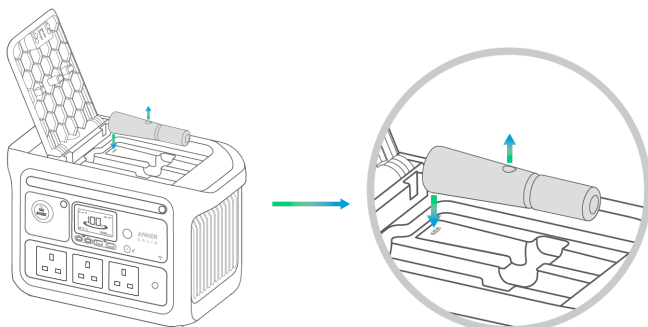

⚠ When charging camping lights, please make sure the power station is turned on.
Use the Extension Pole

1. Stretch the multifunctional extension pole as long as needed, with a maximum length of 1m.
2. Open the extension rod connection port.
3. Tighten the extension rod through the bottom screw.
4. The camping lights can be attached to the extension rod through the magnetic ball.

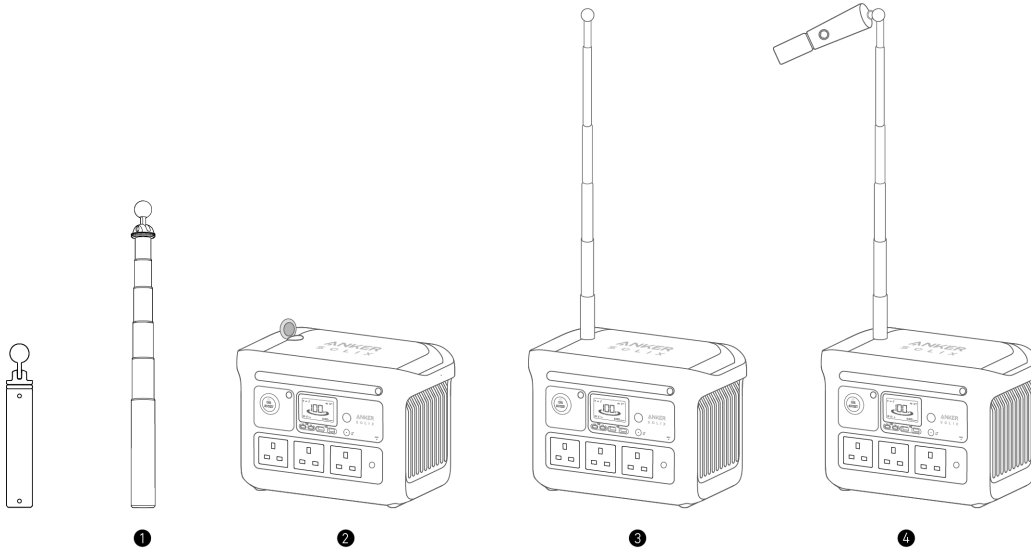

Uninterruptible Power Supply (UPS)

To use the UPS feature, connect your power station to a wall outlet with the AC charging cable, then press the AC outlet button and connect your devices via the AC output ports.

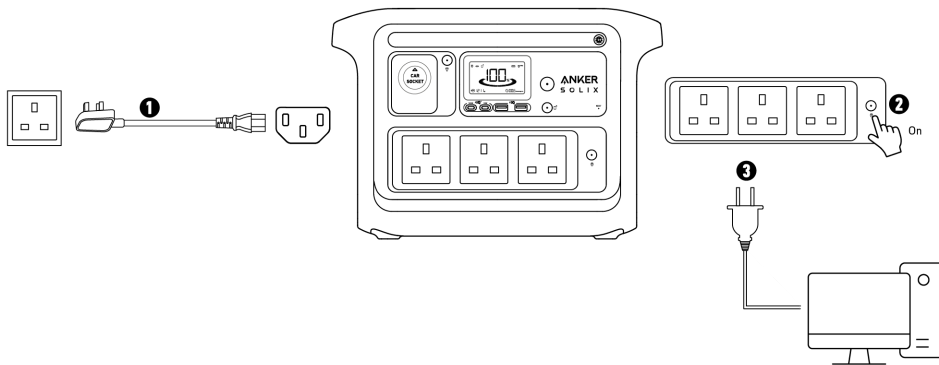

SurgePad™

Using the SurgePad™ feature, the power station can power high-wattage devices up to 1600W without overload.

- SurgePad™ automatically turns on when the total output exceeds the rated output, allowing the power station to deliver rated power to high-wattage devices.
- SurgePad™ does not function in bypass mode (when the power station is being charged with the AC output on).
- SurgePad™ works better with devices that generate heat, but does not support precision instruments and other devices that have voltage protection or strict voltage requirements. To see if SurgePad™ works with your high-wattage devices, try powering them with the power station.

Anker App for Smart Control

You can remotely control your power station using the Anker app.

1. Download the Anker app from the App Store (iOS devices) or Google Play (Android devices), or by scanning the QR code.

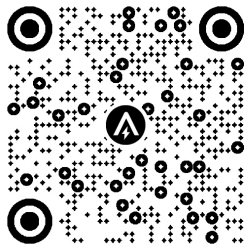

2. Connect the device to a network before using the app for the first time. After connecting successfully, you can connect your device off-grid.

3. Firmware update: You will be informed once a new firmware version is detected when you connect the power station to the app. During the update, ensure the power station is AC charged and connected to Wi-Fi.

Light

Ambient light

Press the button once to turn on the ambient light, and press again up to 2 times to switch between brightness levels.

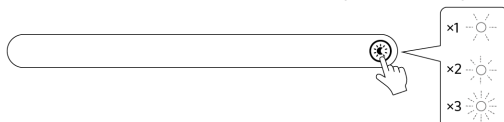

SOS Mode

Hold the button for 2 seconds to turn on SOS mode.

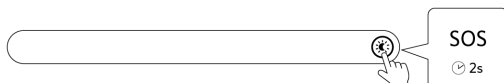

FAQ

Q1: What is the maximum power output of the AC output ports?

The AC output ports can deliver a maximum of 1200W rated power to connected devices.

Q2: What should I do when using a solar charger to charge my power station?

The solar input supports an 11–60V solar charger with an XT–60 connector. The supported current is 10A max. We recommend using Anker solar panels (200W or 400W) to get the best compatibility.

Q3: Can the USB-C ports charge the power station (input only), or are they output only?

The USB-C ports support output only.

Q4: What should I do when AC recharging fails?

If AC recharging does not work, check if the overload protection switch is turned on. If it is on, press down to reset and then continue recharging.

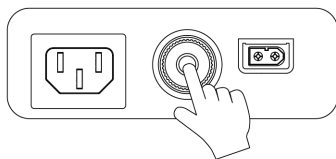

Q5: How do I reset my power station?

If your power station is not working correctly, insert a paper clip or pin into the reset hole for 1 second for a factory reset. If the power station still doesn't work, please contact support@anker.com.

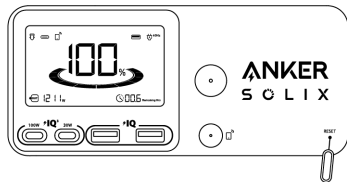

Q6: Why is the power station not working after it hasn't been used for a long time?

If the power station is stored at a low capacity for a long time, lithium batteries will self-consume power which may lead to a quick discharge. This often leads to poor conductivity and a reduced battery lifespan that causes the battery not to work.

Q7: How should I store and maintain the power station?

When storing your power station, please make sure that you:

- 1) Turn off the main power button.
- 2) Store the power station in a dry and cool environment.
- 3) Check the remaining battery capacity each week. If the battery level is below 30%, fully charge the power station. Do not forget to charge it to 100% once every 3 months.

Specifications

Battery type	LiFePO(4) Cell
Cell part number	Nanjing Cbak Energy Technology Co. Ltd 32140FS - 15000mAh
Cell number	16S1P
Cell Capacity	768Wh
AC Input	220-240V~ 10A Max, 50Hz/60Hz, L+N+PE
AC Input Power (Charging)	750W Max
AC Input Power (Bypass Mode)	2070W Max
AC Input Power (UltraFast Charging)	1100W Max
Solar Panel Input	11-60V=10A(300W Max)
Car Charger Output	12V=10A
AC Output	230V~ 5.22A, 50Hz, 1200W Max
Max Device(s) Power (with SurgePad™)	1600W
USB-A Output	5V=2.4A Per Port
USB-C Output (100W)	5V=3A / 9V=3A / 15V=3A / 20V=5A(100W Max)
USB-C Output (30W)	5V=3A / 9V=3A / 12V=2.5A(30W Max)
AK-01 Camping Light Capacity	2600mAh / PCS
AK-01 Camping Light Charger Output	5V=1A Per Port
UPS	20ms
Discharging Temperature	-4°F-104°F / -20°C-40°C
Charging Temperature	32°F-104°F / 0°C-40°C
Size	37.1×20.5×25 cm / 14.61×8.07×9.84 in
Net Weight	10.9 kg